



Dimensions

Product dimensions (mm)	Ø166 x 54
Net weight (g)	600
Drilling hole (mm)	Ø150

Scheme

Scheme

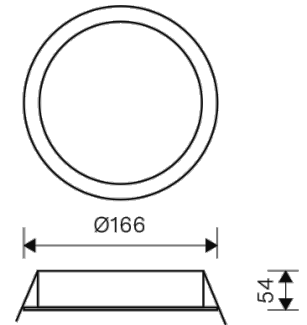

ECOLED 1400 PLX E 33 IP44/20 830

DESCRIPTION

Luxiona basic round fix downlight from the TROLL family Ecoled. Downlight to be used as general indoor lighting for offices, hospitals commercial areas or residential & contract spaces. Downlight designed for ceiling recessed installation. Luminaire body made of synthetic material with finish in White. Luminaire has a degree of isolation vs. environment of IP44/20. Luminaire built-in a polycarbonate opal diffuser with a beam angle of 110°. Luminaire adds in a 10 W LED source with colour temperature of 3000K, Colour reproduction higher than 80% and a chromatic dispersion lower than 3 SMDC. Fixture has n output flux of 1046 Lm, with an efficiency of 87,2 Lm/W and a total consumption of 12 W. The average life for the luminaire is (h) 25000 [L70B10]. Luminaire built-in an Electronic Control Gear fed at 220...240V 50/60Hz.

Product

Real power (W)	12
Real luminous flux (Lm)	1046
Luminous efficiency (Lm/W)	87,2
Beam angle (°)	110
Life time (h)	25000 (L70B10)
IP	IP44/20
Electrical class insulation	Class 2
Operating temperature	from -20°C to 35°C
Electrical feeding	220..240V, 50/60Hz
Colour (RAL)	White(9010)
Energy efficiency class	A+
Diffuser	PMMA opal diffuser

Control gear

Control gear included	Yes
Control gear	Electronic Control Gear
Power Factor	0,9
Flicker Free	Flicker Free

Light source

Light source included	
Light source	Led
Type of LED	Mid-Power
Nominal power (W)	10
Nominal luminous flux (Lm)	1400
Average life time (h)	25000

Item code	11.1525.1301.33
Product type	Indoor Lighting
Category	Recessed Downlights
Family	Ecoled
Subfamily	Ecoled
Materials	Luminaire body made of synthetic material with finish in White.
Optical system	Luminaire built-in a polycarbonate opal diffuser with a beam angle of 110°.
Installation instructions	Downlight designed for ceiling recessed installation.

Pictograms

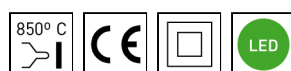

Colour temperature (K)	3000
Colour consistency (SDCM)	3
CRI	80

Photometry

Photometry

